

Article number: 2311111315

Description: E+G Visual flow indicators HVF.92-E-1/2

Measures

HVF-E (G3/8 - G1/2)

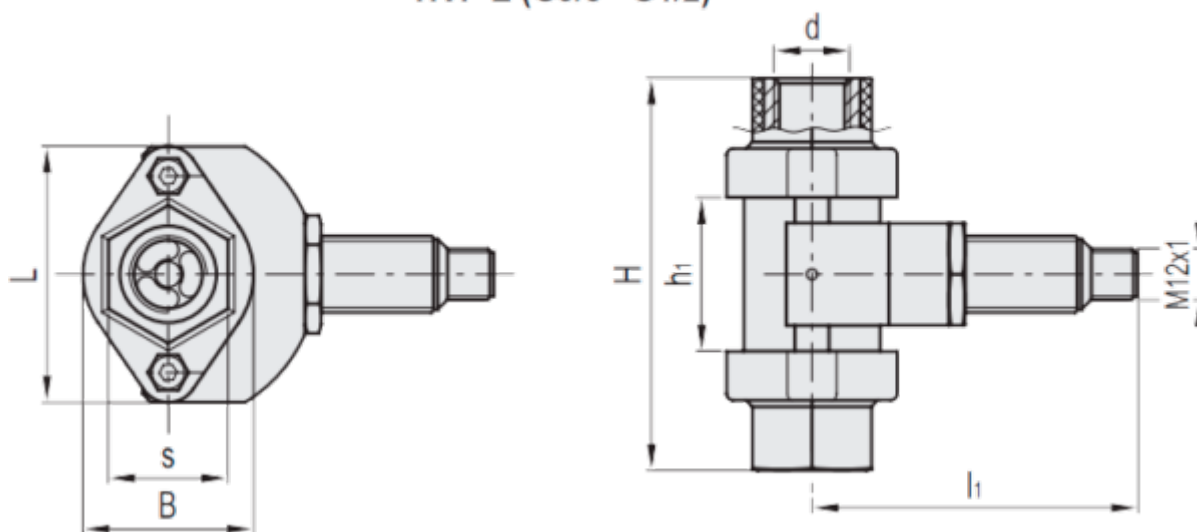

B = 40
d = 1/2
g = 230
H = 92
h1 = 36
L = 60
s = 28